



MAHAGROUP

CONNECT SERIES

Roller Brake Testers

Technical Information

TI023001_008-en

A decorative graphic element consisting of several overlapping wavy lines. One prominent line is red, while the others are white. These lines originate from the left edge of the page and extend horizontally across the middle section.

Instructions for Updating the Firmware

© MAHA Maschinenbau Haldenwang GmbH & Co. KG

The reproduction, distribution and utilisation of this document as well as the communication of its contents to others without explicit authorisation is prohibited. Offenders will be held liable for the payment of damages. All rights reserved in the event of the grant of a patent, utility model or design.

The contents have been checked with great care; however, errors cannot be fully excluded. Illustrations are examples and may differ from the original product. Subject to technical change without notice.

Manufacturer

MAHA Maschinenbau Haldenwang GmbH & Co. KG
Hoyen 20
87490 Haldenwang
Germany

Phone: +49 8374 585-0
Fax: +49 8374 585-590
Mail: maha@maha.de
Web: www.maha.de

Service

MAHA SERVICE CENTER
Maybachstraße 8
87437 Kempten
Germany

Phone: +49 8374 585-100
Fax: +49 8374 585-491
Mail: service@maha.de
Web: www.mahaservicecenter.de

Contents

1	Description	3
2	Before Starting the Firmware Update	3
3	ZM Firmware Update	4
3.1	Circuit Diagram ZM Update Cable	4
3.2	Perform Update	4
4	IFM Firmware Update	9
4.1	Circuit Diagram IFM Update Cable	9
4.2	Perform Update	10
5	Error Handling	14

1 Description

These instructions apply to all changes of the C_MBT software to higher versions.

During this step, the firmware (FW) of the central module (ZM) and of the interface module (IFM) in the floor assembly must be updated in addition to the software (SW) of the ZM. The FW update is also referred to as “flashing” the respective processor. For safety reasons, this can be done only by using a cable specially provided for this purpose.

IMPORTANT:

The firmware update of ZM and IFM described below can be performed only with firmware version ZM 02.05.04 or higher! Boards with older versions must be replaced through MAHA’s spare parts service.

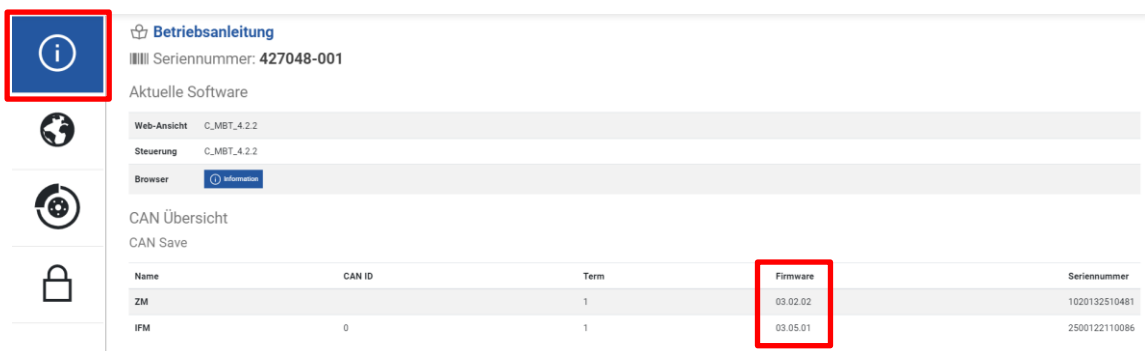

Betriebsanleitung
Seriennummer: 427048-001

Aktuelle Software

Web-Ansicht C_MBT_4.2.2
Steuerung C_MBT_4.2.2
Browser [Information](#)

CAN Übersicht
CAN Save

Name	CAN ID	Term	Firmware	Seriennummer
ZM		1	03.02.02	1020132510481
IFM	0	1	03.05.01	2500122110086

The currently installed firmware version can be found in the Info menu.

2 Before Starting the Firmware Update

- ▶ After completion of the ZM software update, this error message may appear, indicating that a firmware update is necessary:

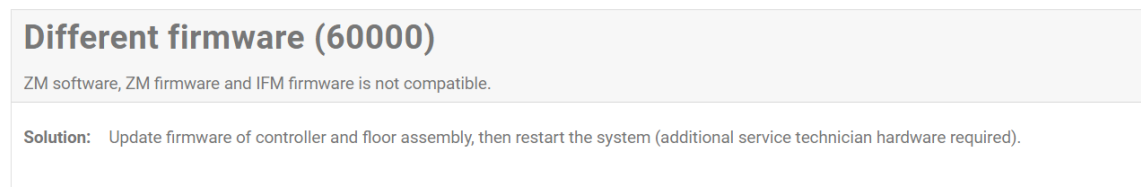

Different firmware (60000)

ZM software, ZM firmware and IFM firmware is not compatible.

Solution: Update firmware of controller and floor assembly, then restart the system (additional service technician hardware required).

The procedure is described in the following sections.

3 ZM Firmware Update

3.1 Circuit Diagram ZM Update Cable

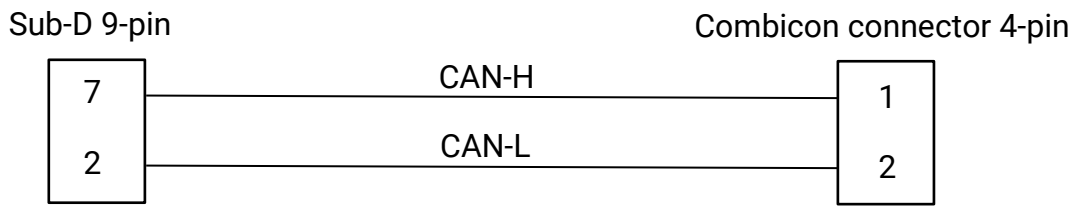

Art. no. 1406593 (= 1 set of adapter cables, contains ZM update cable and IFM update cable)

Combicon connector of ZM update cable

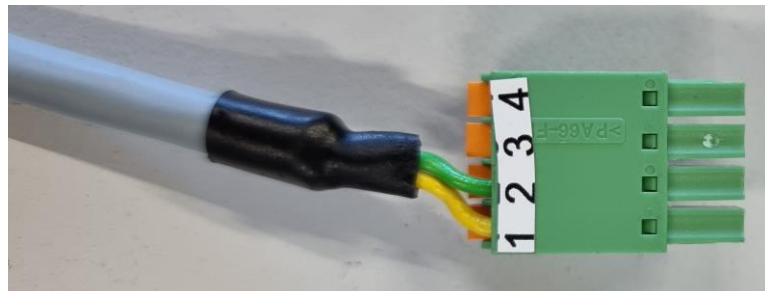

3.2 Perform Update

- 1 Turn off the main switch of the test stand.
- 2 Connect the ZM update cable with *one* Combicon connector:
 - 2.1 Disconnect the option module (if present) from the central module.

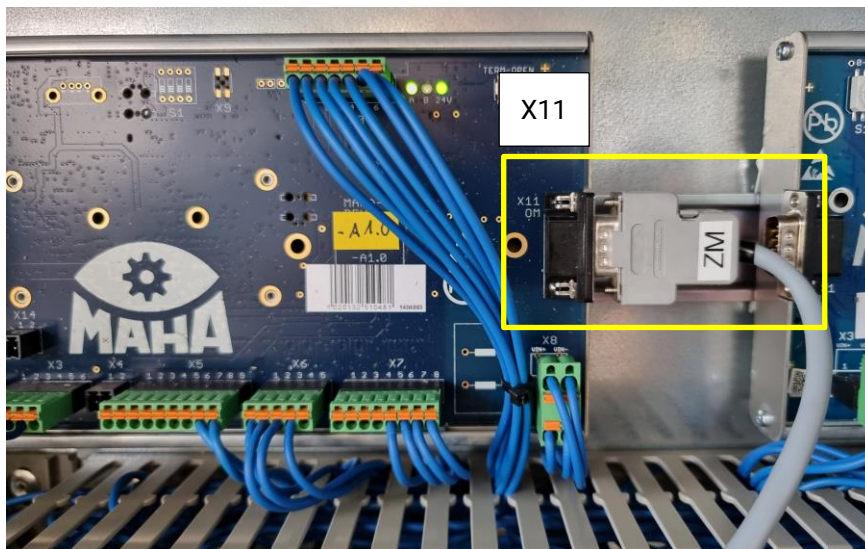

- 2.2 Connect the Sub-D connector of the ZM update cable to the option module CAN (X11) of the ZM. Ensure that the ZM update cable is firmly connected, does not wobble and is not under tension.

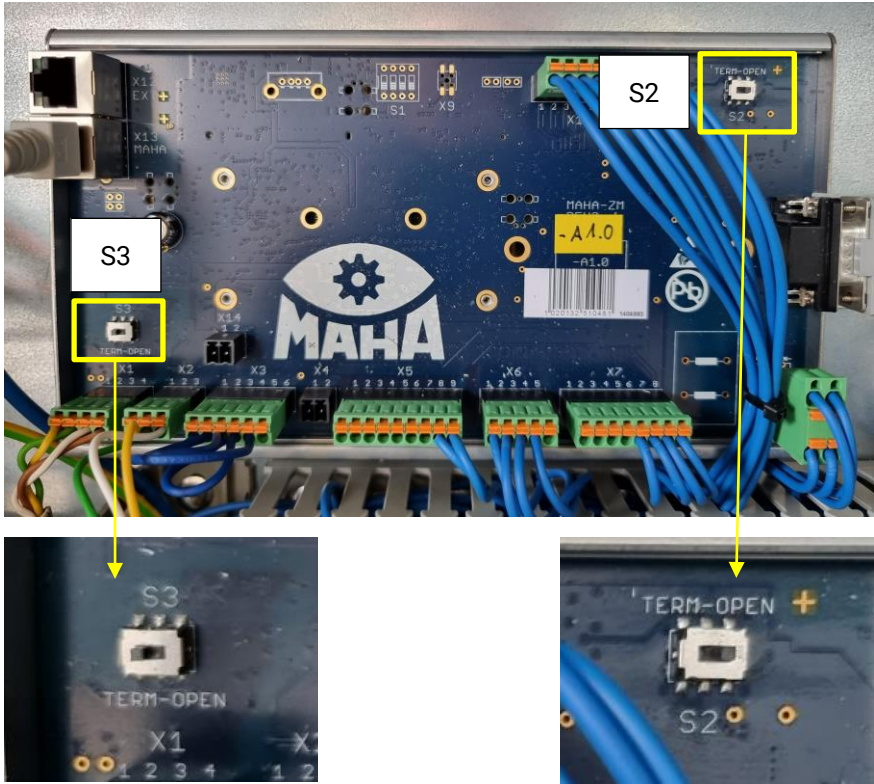

2.3 Note existing CAN termination at S2 and S3 of the ZM so that it can be restored after updating.
 Then make the following settings: S2 OPEN | S3 TERM

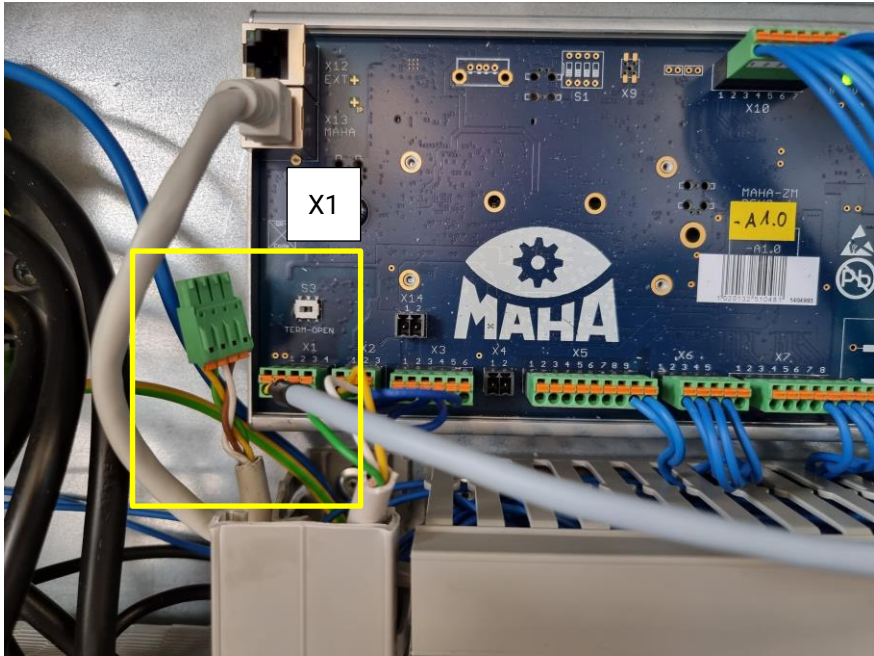

2.4 Disconnect the IFM-CAN cable from X1 of the ZM and connect the four-pin Combicon connector of the ZM update cable instead.



Overall view after connecting the ZM update cable

- 3 Turn on the main switch.
- 4 Start the firmware update:

CAN bus error (10002)

Communication error between ZM and IFM.

Solution:

- Turn off main switch and back on again.
- Check CAN cable connection between ZM X1 and IFM X1.
- Check IFM CAN address.
- Contact service.

- 4.1 Ignore error messages.
- 4.2 Log in as technician to the Technician menu.
- 4.3 Under “Settings”, navigate to “Software Update”.
- 4.4 Scroll down the page.

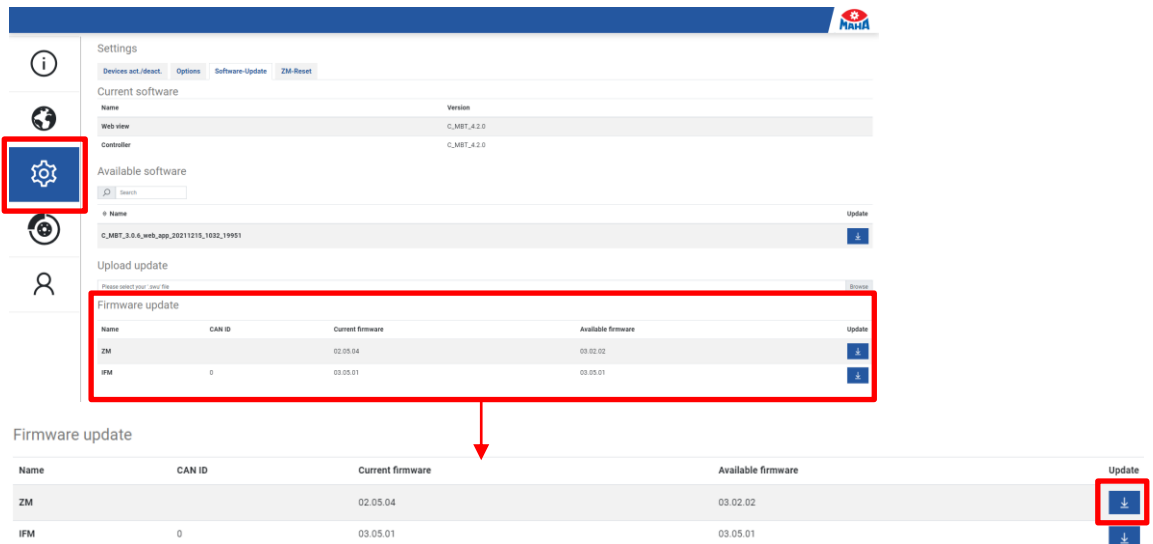

4.5 Under category “Firmware Update”, select the ZM update by clicking on the update button.

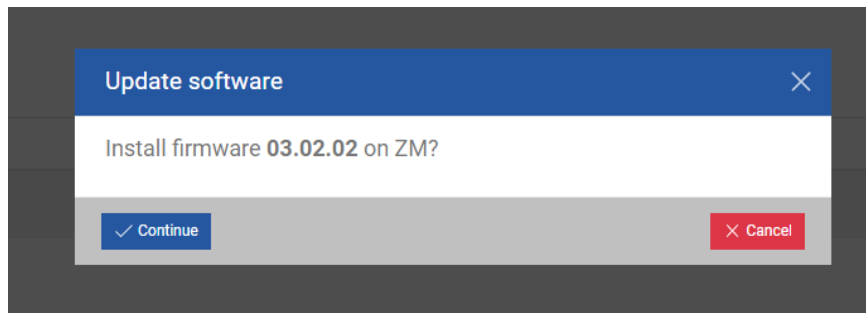

4.6 Confirm update dialog.

IMPORTANT:

If the user interface briefly loses the connection while the update is already running, *do not* switch off the test stand! As soon as the connection is re-established, re-enter the menu, log in and navigate to the update page. *Do not* restart the update!

The page should automatically display the current progress again. Otherwise, wait at least 5 minutes before switching off the test stand and continue with removing the cable.

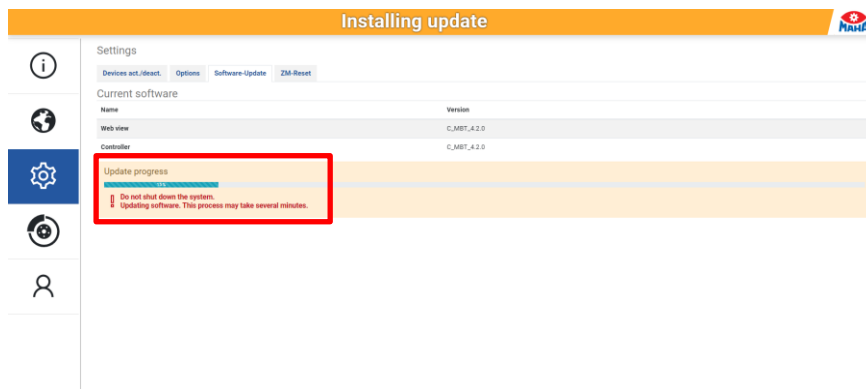

► Installing update.

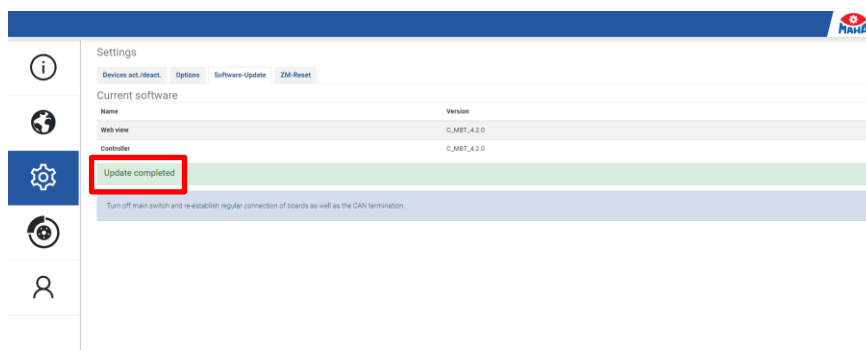

4.7 Wait for update progress until “Update completed” is signalised.

- 5 Turn off the main switch.
- 6 Remove the ZM update cable.
- 7 Restore the CAN termination. (If the IFM firmware is updated afterwards, this step is not necessary.)
- 8 Turn on the main switch.

4 IFM Firmware Update

4.1 Circuit Diagram IFM Update Cable

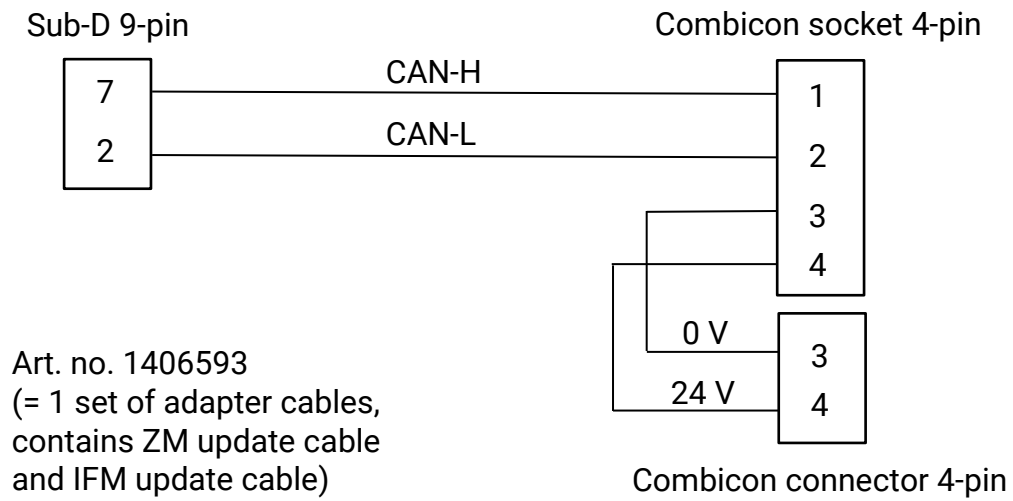

Combicon socket and
connector of IFM update
cable

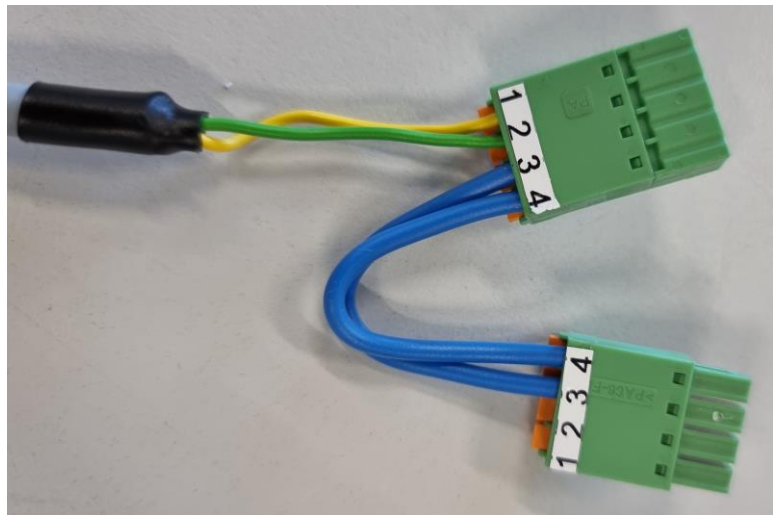

IMPORTANT:

In the event that two IFMs are installed, the update must be performed *separately* for each IFM.

4.2 Perform Update

- 1 Turn off the main switch of the test stand.
- 2 Connect the IFM update cable with two Combicon connectors:
 - 2.1 Disconnect the option module (if present) from the central module.

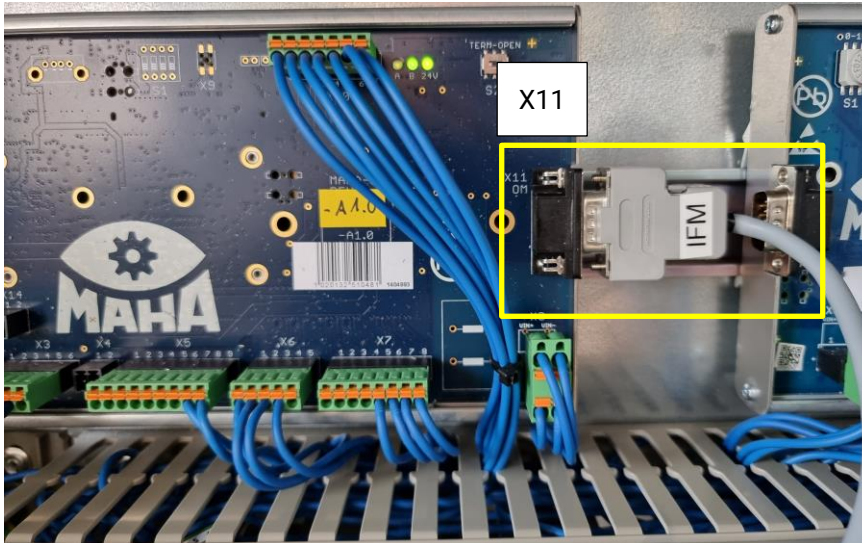

- 2.2 Connect the Sub-D connector of the IFM update cable to the option module CAN (X11) of the ZM. Ensure that the IFM update cable is firmly connected, does not wobble and is not under tension.

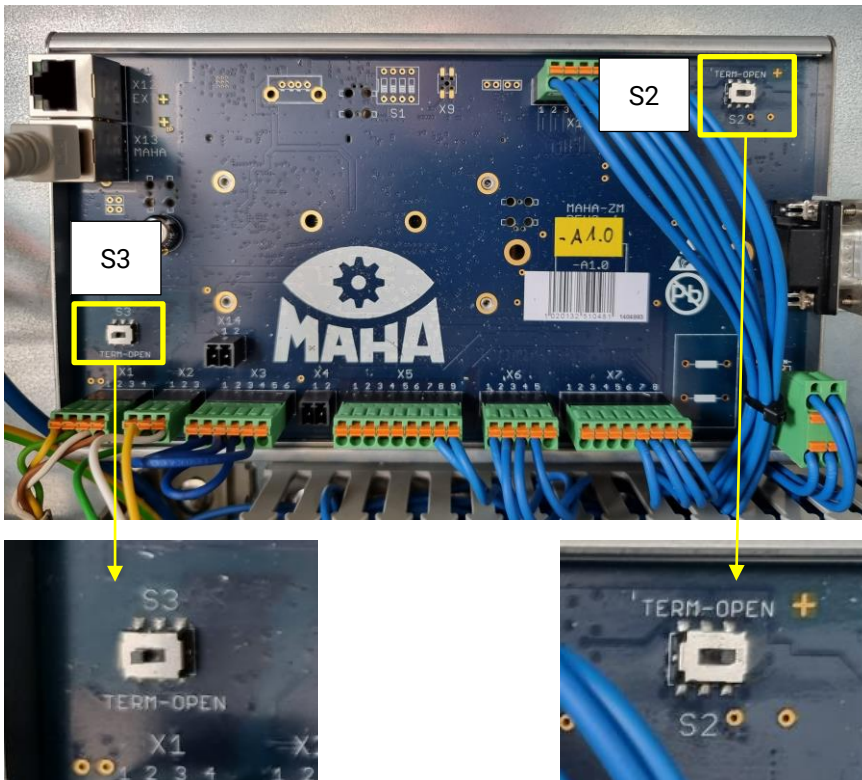

2.3 Note existing CAN termination at S2 and S3 of the ZM so that it can be restored after updating.

Then make the following settings: S2 OPEN | S3 TERM

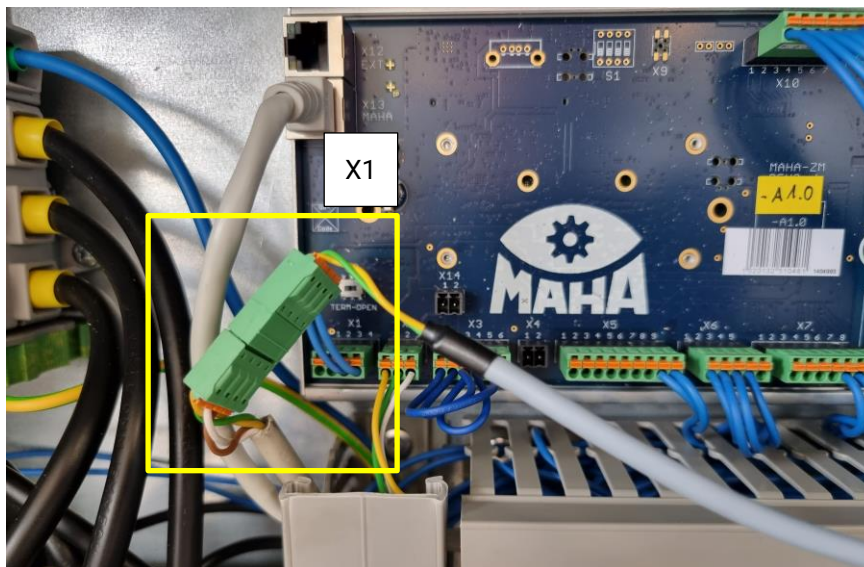

2.4 Disconnect the IFM-CAN cable from X1 of the ZM and connect the four-pin Combicon connector of the IFM update cable instead.

2.5 Plug the IFM-CAN cable into the Combicon socket of the IFM update cable.

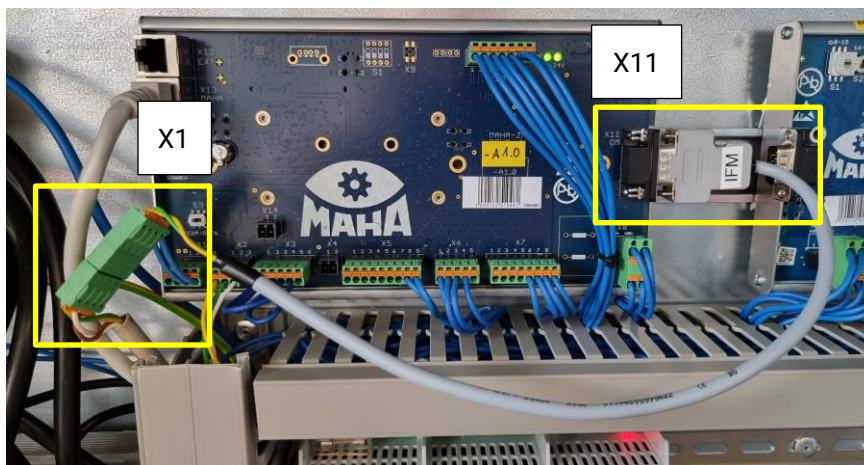

Overall view after connecting the IFM update cable

3 Turn on the main switch.

4 Start the firmware update:

CAN bus error (10002)

Communication error between ZM and IFM.

Solution:

- Turn off main switch and back on again.
- Check CAN cable connection between ZM X1 and IFM X1.
- Check IFM CAN address.
- Contact service.

4.1 Ignore error messages.

4.2 Log in as technician to the Technician menu.

4.3 Under "Settings", navigate to "Software Update".

4.4 Scroll down the page.

Settings

Devices act./diagn. Options **Software-Update** ZM-Reset

Current software

Name	Version
Web view	C.MBT_4.2.0
Controller	C.MBT_4.2.0

Available software

Search

Name	Update
C.MBT_3.0.0_web_app_20211215_1032_19951	↓

Upload update

Firmware update

Name	CAN ID	Current firmware	Available firmware	Update
ZM		03.02.02	03.02.02	↓
IFM		03.02.02	03.05.01	↓

Firmware update

Name	CAN ID	Current firmware	Available firmware	Update
ZM		03.02.02	03.02.02	↓
IFM		03.02.02	03.05.01	↓

4.5 Under category "Firmware Update", select the ZM update by clicking on the update button.

Update software

Install firmware 03.05.01 on IFM?

✓ Continue

✗ Cancel

4.6 Confirm update dialog.

IMPORTANT:

If the user interface briefly loses the connection while the update is already running, *do not* switch off the test stand! As soon as the connection is re-established, re-enter the menu, log in and navigate to the update page. *Do not* restart the update!

The page should automatically display the current progress again. Otherwise, wait at least 5 minutes before switching off the test stand, and continue with removing the cable.

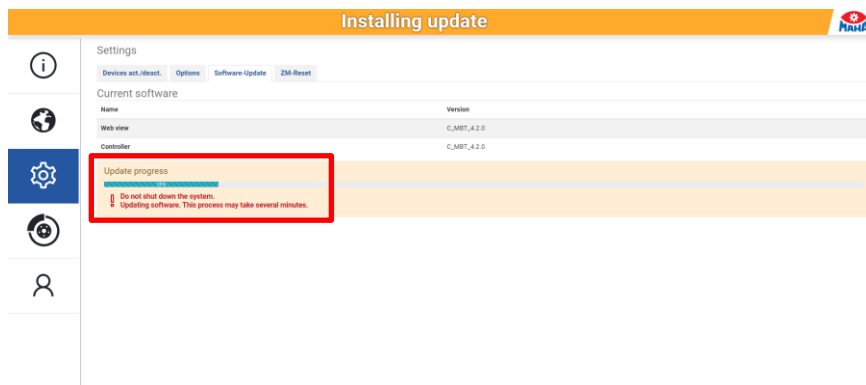

► Installing update.

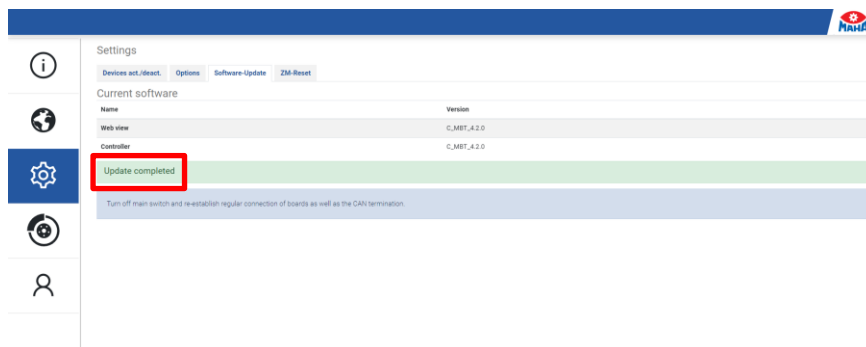

4.7 Wait for update progress until “Update completed” is signalled.

- 5 Turn off the main switch.
- 6 Remove the IFM update cable.
- 7 Restore the CAN termination.
- 8 Turn on the main switch.

5

Error Handling

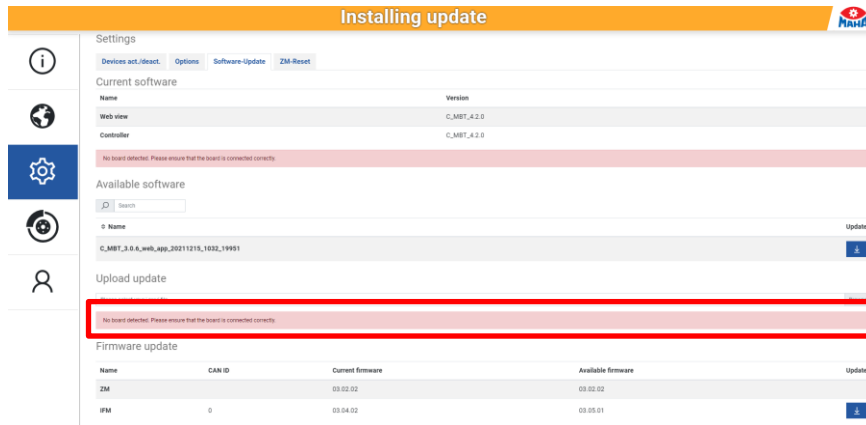

If an error occurs during the firmware update, it is displayed. Follow the instructions in the error text, then restart the update.

Possible error texts:

- The selected board type is not permitted.
- An internal error has occurred.
- An update is already being performed.
- A runtime error has occurred.
- The selected firmware cannot be read.
- No board could be detected. Please ensure the correct connection of the board.
- An incorrect board was detected. Please choose the correct firmware and make sure the board is connected correctly.
- The attempt to address the board failed. Please make sure that no additional devices are connected via CAN (e.g. option modules).
- Different boards were detected. Please ensure the correct connection of the board.
- It was not possible to put the board into download mode.
- A communication error has occurred.
- Turn off the main switch and restore regular connection of the boards.

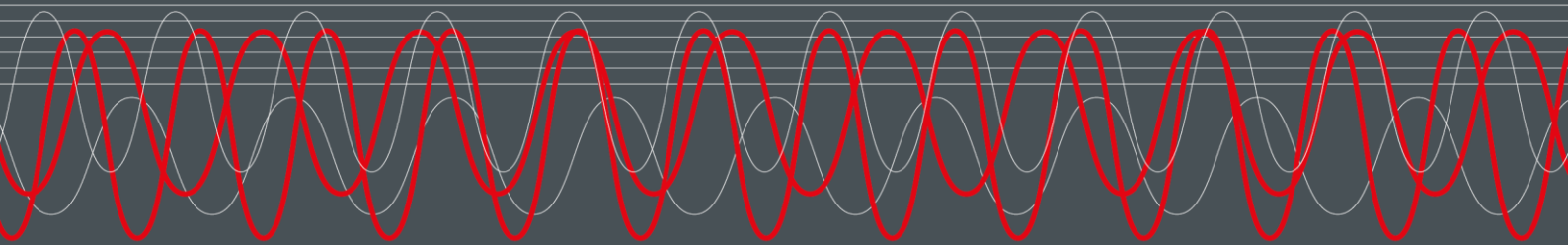

MAHA MASCHINENBAU HALDENWANG GMBH & CO. KG

Hoyen 20
87490 Haldenwang
Germany

☎ +49 8374 585 0
✉ maha@maha.de
🌐 maha.de